

Air Brake Push-In - Fittings

RAUFOSS INTRODUCTION

The RAUFOSS Fitting Programme is a unique and extremely simple method of 'piping up' truck and trailer air brake and air suspension systems

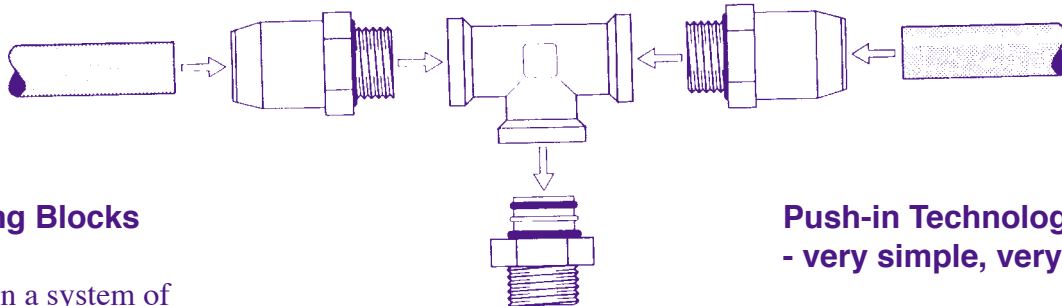

Building Blocks

Based on a system of 'building blocks' the RAUFOSS programme consists of a limited number of components which very simply plug together to form a complete range of fittings.

Complete range of fittings for air systems

Push-In Pipe Connectors

Plug-In Swivels

Building Blocks

Elbows, Tee Pieces,
Unions Hose Nipples
Test Points etc.

Please note: The P5 Swivel replaces the old P3 and P4 but is not interchangeable and CANNOT be used with the old fittings or similar fittings from any other manufacturer. The plug-in swivels should not be used between the axles and the chassis or between the truck and trailer.

Application

The RAUFOSS Fitting Programme is a unique system providing a complete range of pipe fittings for use in commercial vehicle Air Brake, Air Suspension and other air controlled systems.

It is fitted as Original Equipment on:

Volvo
Iveco Ford
Scania
Steyr
Sisu
Crane Fruehauf
Dennis Group
Marshall Group
SESR Group

Push-in Technology

- very simple, very quick!

The programme is based on a special Push-In System. The required fitting is made by plugging the building block components together and then the tubing is connected by simply pushing the tube into the fitting.

And this is all done by hand without the need for special tools.

Operating Fluid -

Compressed air

Operating Pressure -

The maximum operating pressure meets the requirements for both Nylon and Hytrel tubing.

Operating Temperature -

Operating temperature of the system is - 40 C to +100 C. Peak temperature allowed is 140 C.

All components are manufactured in a special brass alloy for use with NYLON OR HYTREL tubing in accordance with the following standards:

DIN 743324-DIN 73378
- NFR 12-632 - ISO 7628
- SAE J844

Phone: 01474 321954 Fax: 01474 321988

Air Brake Push-In - Fittings

RAUFOSS - METRIC

STRAIGHT STUD

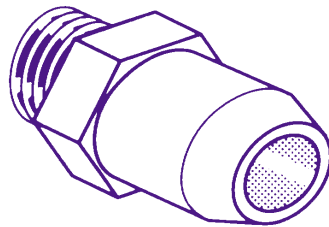

Sizes in mm.

Thread Size	Tube Size	Part No	Pkt No	Thread Size	Tube Size	Part No	Pkt No
M10 x 1	4 x 1	4500	RA500	M10 x 1	10 x 1.5	4521	RA521
M12 x 1.5	4 x 1	4501	RA501	M12 x 1.5	10 x 1.5	4522	RA522
M10 x 1	6 x 1	4502	RA502	M14 x 1.5	10 x 1.5	4523	RA523
M12 x 1.5	6 x 1	4503	RA503	M16 x 1.5	10 x 1.5	4524	RA524
M14 x 1.5	6 x 1	4504	RA504	M22 x 1.5	10 x 1.5	4525	RA525
M16 x 1.5	6 x 1	4505	RA505	M10 x 1	12 x 1.5	4526	RA526
M22 x 1.5	6 x 1	4506	RA506	M12 x 1.5	12 x 1.5	4527	RA527
M10 x 1	8 x 1	4507	RA507	M14 x 1.5	12 x 1.5	4528	RA528
M12 x 1.5	8 x 1	4508	RA508	M16 x 1.5	12 x 1.5	4529	RA529
M14 x 1.5	8 x 1	4509	RA509	M22 x 1.5	12 x 1.5	4530	RA530
M16 x 1.5	8 x 1	4510	RA510	M14 x 1.5	15 x 1.5	4531	RA531
M22 x 1.5	8 x 1	4511	RA511	M16 x 1.5	15 x 1.5	4532	RA532
M10 x 1	10 x 1	4512	RA512	M22 x 1.5	15 x 1.5	4533	RA533
M12 x 1.5	10 x 1	4513	RA513	M12 x 1.5	16 x 2	4534	RA534
M14 x 1.5	10 x 1	4514	RA514	M14 x 1.5	16 x 2	4535	RA535
M16 x 1.5	10 x 1	4515	RA515	M16 x 1.5	16 x 2	4536	RA536
M22 X 1.5	10 x 1	4516	RA516	M22 x 1.5	16 x 2	4537	RA537
M12 x 1.5	10 x 1.25	4517	RA517	M16 x 1.5	18 x 2	4538	RA538
M14 x 1.5	10 x 1.25	4518	RA518	M22 x 1.5	18 x 2	4539	RA539
M16 x 1.5	10 x 1.25	4519	RA519				
M22 x 1.5	10 x 1.25	4520	RA520				

Phone: 01474 321954 Fax: 01474 321988

Air Brake Push-In - Fittings

RAUFOSS - IMPERIAL

STRAIGHT STUD

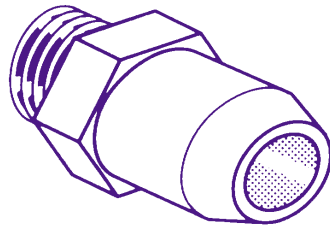

Thread Size	Tube Size	Part No	Pkt No	Thread Size	Tube Size	Part No	Pkt No
1/8 NPT	1/4	4540	RA540	1/4 NPT	1/2	4554	RA554
1/4 NPT	1/4	4541	RA541	3/8 NPT	1/2	4555	RA555
3/8 NPT	1/4	4542		1/2 NPT	1/2	4556	RA556
M10 x 1	1/4	4543	RA543	M12 x 1.5	1/2	4557	RA557
M12 x 1.5	1/4	4544	RA544	M14 x 1.5	1/2	4558	RA558
M14 x 1.5	1/4	4545	RA545	M16 x 1.5	1/2	4559	RA559
M16 x 1.5	1/4	4546	RA546	M16 x 1.5	5/8	4560	RA560
1/4 NPT	3/8	4547	RA547	1/8 NPT	4 x 1	4561	RA561
3/8 NPT	3/8	4548	RA548	1/4 NPT	6 x 1	4562	RA562
1/2 NPT	3/8	4549	RA549	1/4 NPT	8 x 1	4563	RA563
M10 x 1	3/8	4550	RA550	1/4 NPT	10 x 1.5	4564	RA564
M12 x 1.5	3/8	4551	RA551	1/4 NPT	12 x 1.5	4565	RA565
M14 x 1.5	3/8	4552	RA552				
M16 x 1.5	3/8	4553	RA553				

Air Brake Push-In - Fittings

RAUFOSS - METRIC

STRAIGHT CONNECTOR

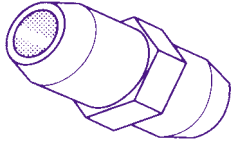

Tube Size	Part No	Pkt No
6 x 1	4566	RA566
8 x 1	4567	RA567
9 x 1	4647	
10 x 1	4568	RA568
10 x 1.25	4569	RA569
10 x 1.5	4570	RA570
11 x 1.5	4648	
12 x 1.5	4571	RA571
15 x 1.5	4572	RA572
16 x 2	4649	

STRAIGHT BULKHEAD ADAPTOR

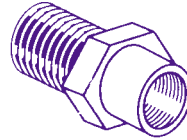

Male	Female	Part No	Pkt No
M18 x 1.5	M16 x 1.5	4613	RA613

STRAIGHT BULKHEAD ADAPTOR

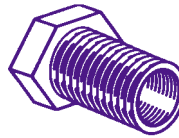

Thread Size Male	Thread Size Female	Part No	Pkt No
M22 x 1.5	M16 x 1.5	4630	RA630

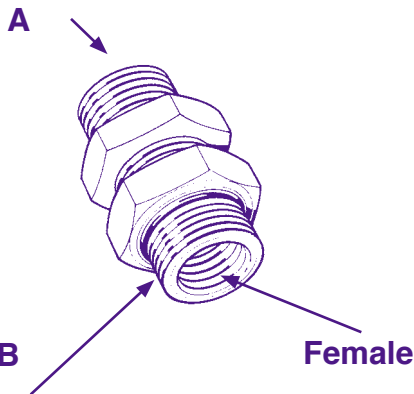

STRAIGHT BULKHEAD ADAPTOR

Thread A	Thread B	Thread Size Female	Part No	Pkt Part No
M22 x 1.5	M22 x 1.5	M16 x 1.5	4499	RA499
M16 x 1.5	M22 x 1.5	M16 x 1.5	4631	RA631
M22 x 1.5	1/2 NPT	M16 x 1.5	4614	
M22 x 1.5	M16 x 1.5	M10 x 1	4494	

STRAIGHT BULKHEAD ADAPTOR

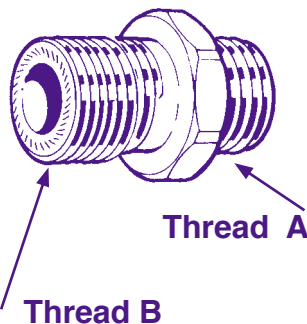

Thread A	Thread B	Part No
M12 x 1.5	M12 x 1.5	4629
M16 x 1.5	M16 x 1.5	4632

Air Brake Push-In - Fittings

RAUFOSS - METRIC Amended 15.02.10

Raufoss Adaptors with integral 'o' ring are on page 75

TEE ADAPTOR FEMALE THREAD - THREAD - THREAD

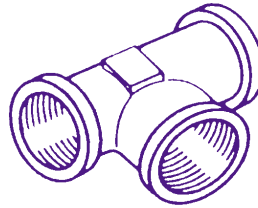

Thread Size	Part No	Pkt Part No
M12 x 1.5	4593	RA593
M16 x 1.5	4594	RA594
M22 x 1.5	4595	RA595

TEE ADAPTOR - FEMALE (With Bracket)

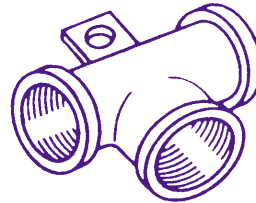

Thread Size	Part No	Pkt Part No
M16 x 1.5	4596	RA596

SIDE STUD TEE

Thread Size	Part No
M16 x 1.5	4651

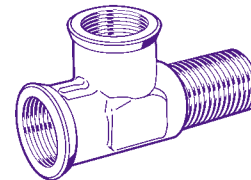

BRANCH STUD TEE

Thread Size	Part No
M16 x 1.5	4643

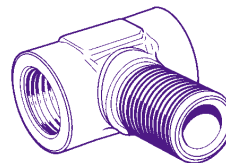

BLANKING PLUG

comes with integral 'o' ring



Thread Size	Part No
M12 x 1.5	4717
M16 x 1.5	4715
M22 x 1.5	4716

FEMALE SOCKET

Thread Size	Part No
M16 x 1.5	4645
M22 x 1.5	4646

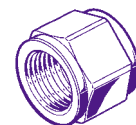

Phone: 01474 321954 Fax: 01474 321988

Air Brake Push-In - Fittings

RAUFOSS - METRIC

ELBOW FEMALE TO MALE

A	B	C	Part No	Pkt No
M16	M16	N/A	4587	RA587
M16	M22	M16	4588	RA588
M22	M22	M16	4670	

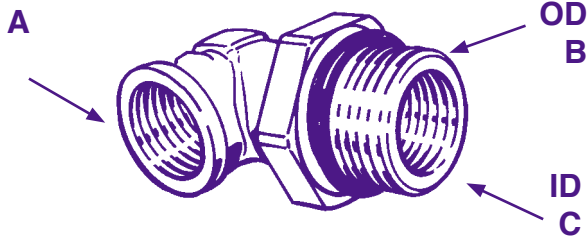

ELBOW ADAPTOR THREAD - THREAD



Thread Size	Thread Size	Part No	Pkt No
M12 x 1.5	M12 x 1.5	4581	RA581
M16 x 1.5	M16 x 1.5	4582	RA582
M22 x 1.5	M22 x 1.5	4583	RA583

ELBOW ADAPTOR FEMALE/ MALE

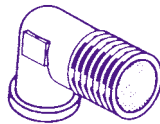

Thread Size Female	Thread Size Male	Part No	Pkt No
M12 x 1.5	M12 x 1.5	4584	RA584
M16 x 1.5	M16 x 1.5	4585	RA585
M16 x 1.5	M22 x 1.5	4586	RA586

45° ELBOW ADAPTOR

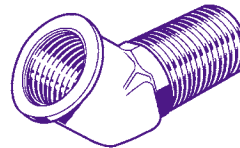

Thread Size	Part No
M16 x 1.5	4497
M22 x 1.5	4498

CROSS ADAPTOR

Thread Size	Part No
M16 x 1.5	4637

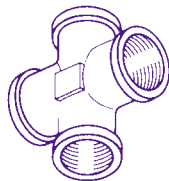

LOCKNUT WITHOUT O RING

Thread Size	Part No
M22 x 1.5	4628

LOCKNUT C/W O RING

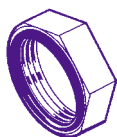

Thread Size	Part No
M12 x 1.5	4640
M16 x 1.5	4641
M22 x 1.5	4642

Air Brake Push-In - Fittings

RAUFOSS

P5 PLUG-IN SYSTEM INTRODUCTION

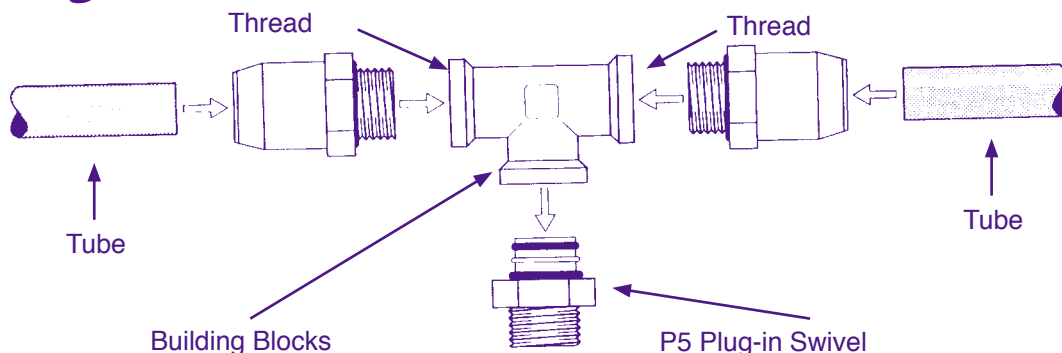

The main benefits of the Raufoss P5 Swivel System are:

Ease of assembly - can be quickly put together by simply pushing the P5 swivel into its appropriate matching part i.e. P5 Elbows and P5 Tee Pieces

Once fitted it is easy to turn the fittings whichever way the tubing needs to be directed.

Two snap rings give added security when assembled. Once the first ring engages the fittings will not disengage. When the second ring engages the fitting is then completely secure and gives an airtight seal.

Male Metric threads have EPDM "O" rings on scaling surfaces which provide excellent seals and are designed to fit all valve manufacturer's ports.

Operating temperature of between - 40C to 100C.

The Swivel assemblies can be unscrewed from the valves etc. without the need for the tubing to be taken out of the fittings thus retaining an airtight seal.

Male threads range from M10 to M22 and are also available in 1/8", 1/4", 3/8", 1/2" NPTF.

P5 Swivel Elbows & Tees with M16 female threads allow for a large range of M16 male connectors to be fitted.

Time saving, fewer parts to stock and no need for special assembly tools.

MSK460 - Maxi-Stor Box

Contains all popular Raufoss P5 components
Ask our sales team for contents
and prices

Phone: 01474 321954 Fax: 01474 321988

Air Brake Push-In - Fittings

RAUFOSS - METRIC

P5 COMPONENTS

STRAIGHT SWIVEL ADAPTOR

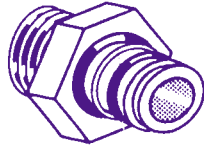

Swivel	Thread Size	Part No	Pkt No
P5	M10 X 1.0	4615	RA615
P5	M12 X 1.5	4616	RA616
P5	M14 X 1.5	4617	RA617
P5	M16 X 1.5	4618	RA618
P5	M22 X 1.5	4619	RA619
P5	1/8 NPT	4620	RA620
P5	1/4 NPT	4621	RA621
P5	3/8 NPT	4622	RA622
P5	1/2 NPT	4623	RA623

ADAPTOR - THREAD/SWIVEL

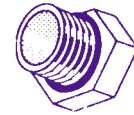

Swivel	Thread Size	Part No	Pkt No
P5	M22 X 1.5	4601	RA601

DODECAHEDRON THREAD/SWIVEL ADAPTOR



Swivel	Thread Size	Part No	Pkt No
P5	M16 X 1.5	4602	RA602
P5	M22 X 1.5	4603	RA603

STRAIGHT SWIVEL BULKHEAD

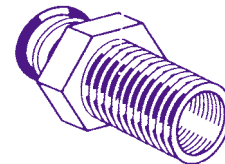

Swivel	Male Thread	Female Thread	Part No	Pkt No
P5	M22	M16	4624	RA624
P5	M22	3/8NPT	4625	RA625

SWIVEL HOSETAIL

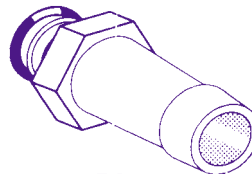

Swivel	Hose I.D.	Part No	Pkt No
P5	11 mm	4626	RA626
P5	13 mm	4627	RA627

Swivel Hoesetails ref: Part Nos. 4626 and 4627 can only be used in conjunction with adaptors ref: Part Nos 4602 and 4603

Phone: 01474 321954 Fax: 01474 321988

Air Brake Push-In - Fittings

RAUFOSS - METRIC

P5 COMPONENTS

**TEE ADAPTOR
SWIVEL/THREAD
(Centre)**

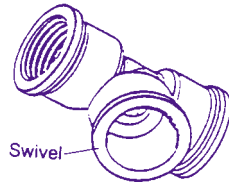

Swivel	Thread Size	Part No	Pkt No
P5	M12 x 1.5	4589	RA589
P5	M16 x 1.5	4590	RA590

**TEE ADAPTOR
SWIVEL/THREAD
(On Run)**

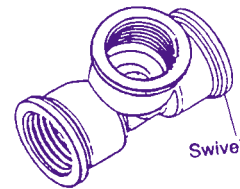

Swivel	Thread Size	Part No	Pkt No
P5	M12 x 1.5	4591	RA591
P5	M16 x 1.5	4592	RA592

3 - WAY ADAPTOR

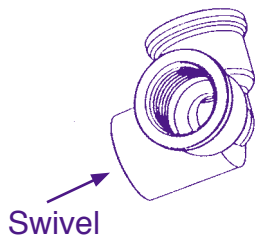

Swivel	Thread Size	Part No	Pkt No
P5	M16 X 1.5	4597	RA597

**4-WAY ADAPTOR
SWIVEL/THREAD**

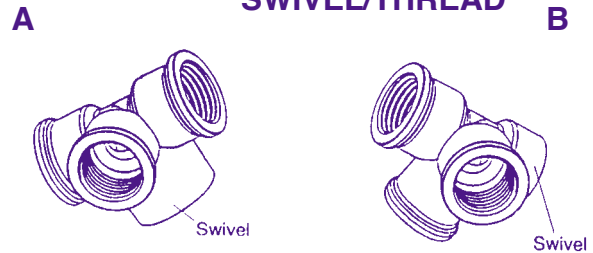

Swivel	Thread Size	Part No	Pkt No
P5 (A)	M16 x 1.5	4598	RA598
P5 (B)	M16 x 1.5	4599	RA599

B

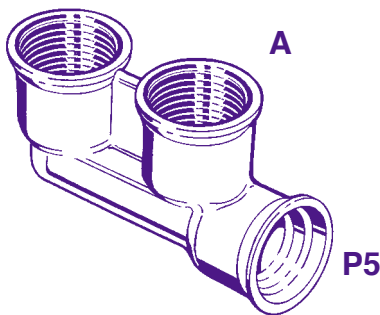

F Fitting P5

Part No	A	B
4638	M12	M12
4634	M16	M16

Air Brake Push-In - Fittings

RAUFOSS - METRIC

P5 COMPONENTS

CROSS ADAPTOR SWIVEL/THREAD

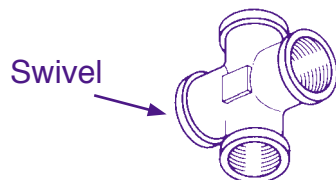

Swivel	Thread Size	Part No	Pkt No
P5	M16 X 1.5	4600	RA600

SWIVEL ELBOW ADAPTOR

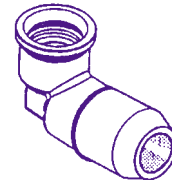

Swivel	Tube Size	Part No	Pkt No
P5	6 x 1	4573	RA573
P5	8 x 1	4574	RA574
P5	10 x 1.25	4575	RA575
P5	10 x 1.5	4576	RA576
P5	12 x 1.5	4577	RA577
P5	16 X 2	4496	

ELBOW ADAPTOR 45° Swivel Thread



Swivel	Thread Size	Part No	Pkt No
P5	M16 x 1.5	4578	RA578

MSK800 - Maxi-Stor Box
Contains fast mover push-in fittings

ELBOW ADAPTOR 90° Swivel Thread



Swivel	Thread Size	Part No	Pkt No
P5	M12 x 1.5	4579	RA579
P5	M16 x 1.5	4580	RA580

STRAIGHT SWIVEL BULKHEAD

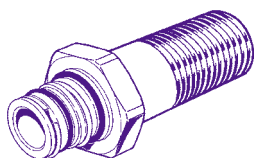

Swivel	Thread Size	Description	Part No
P5	M18 x 1.5	K24 Deg - 12 Swiv	4653

Phone: 01474 321954 Fax: 01474 321988